

Product Dimensions

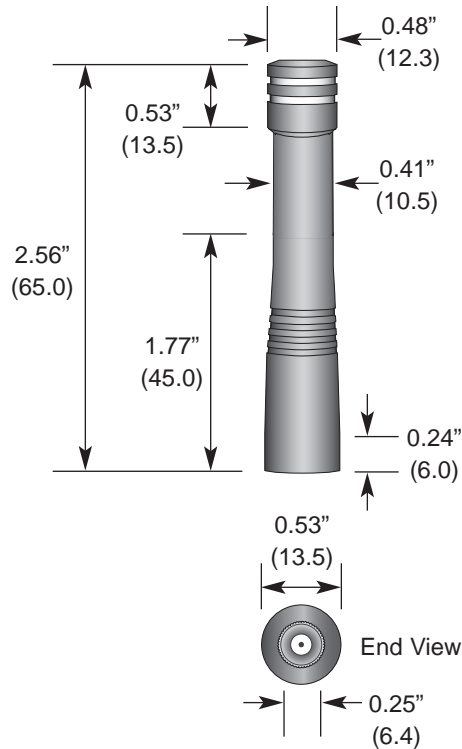

Description



This reduced-height 1/4-wave antenna is ready for years of use thanks to a flexible internal helical that is overmolded with a heavy-duty protective jacket. It's an excellent choice for outdoor applications or for use in adverse environments where the antenna must resist shock, harsh weather, and tampering. HD Series antennas attach via an FCC Part 15 compliant RP-SMA connector.

Features

- Reduced-height helical whip
 - Excellent performance
 - Omni-directional pattern
 - Very low VSWR
 - Heavy-duty construction
 - Damage-resistant
 - Fully weatherized
 - Flexible main shaft
 - Part 15 compliant RP-SMA connector
 - Use with plastic* or metal enclosures
- * Requires proximity ground plane

Electrical Specifications

- Center Freq. 916MHz
- Bandwidth 85MHz
- Wavelength 1/4-wave
- VSWR <2.0 typ. at center
- Impedance 50 ohms
- Connector RP-SMA

Electrical specifications and plots measured on 4.00" x 4.00" reference ground plane

Ordering Information

- ANT-916-CW-HD

VSWR Graph

